

# Molteni & C

## SLOANE — MDT 2017

1—  
5



Sloane is a modular seating programme that can easily adapt to new furnishing solutions in line with contemporary living. It is a dynamic system in which the component parts offer an original interplay of soft volumes. By arranging seating and poufs, cosy corners can be created in which to chill out at will.

**DATASHEET**

REGISTERED  
DESIGN

V.2017

**moltenigroup.com**

Dimensions in millimeters and inches. The right to discontinue and make changes is reserved. This information is based on the latest product information available at the time of printing.

## FINISHES

### COVERS

fabric - leather, completely removable.

### BASE FINISH

pewter colour

Available in fire-resistant version (TB117 and BS5852) for a 10% surcharge.

# Molteni & C

## TECHNICAL INFORMATION

### STRUCTURE INTERIOR

Frame made of solid Fir (Picea abies) and chipboard, with elastic straps.

### STRUCTURE PADDING

High capacity variable density foam polyurethane. Light velvet cover.

### SEAT CUSHION

Insert in shaped polyurethane and sterilised feathers. 100% cotton cover.

### BACK CUSHIONS

Polyester fibre, sterilised feathers. 100% cotton cover.

### BASE

Anodised aluminium in pewter colour set on plastic floor slides.

### REMOVABLE OUTER COVER

(See attached card, specifically for the cover).

2—  
5

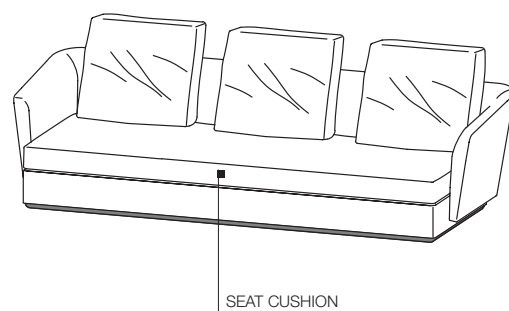
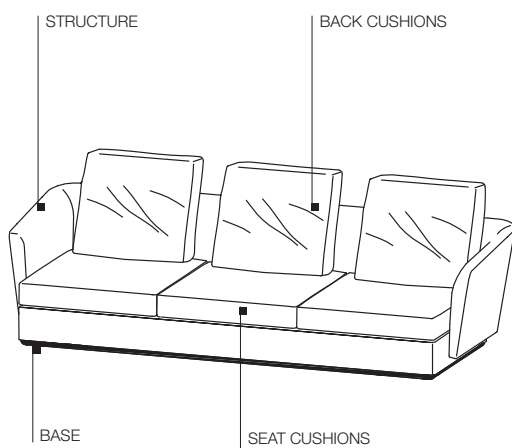

## DATASHEET

REGISTERED  
DESIGN

V.2017

**DIMENSIONS**

**sofa**

W 1920 D 1040 H 900  
W 75 5/8" D 41" H 35 3/8"

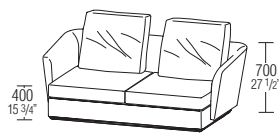

**DI192/A**

W 1920 D 1040 H 900  
W 75 5/8" D 41" H 35 3/8"  
single cushion seating

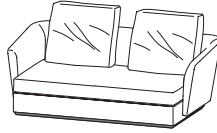

**DI192/B**

W 2320 D 1040 H 900  
W 91 3/8" D 41" H 35 3/8"

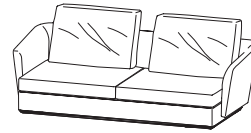

**DI232/A**

W 2320 D 1040 H 900  
W 91 3/8" D 41" H 35 3/8"  
single cushion seating

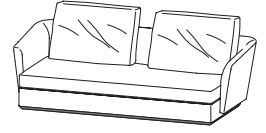

**DI232/B**

**Molteni & C**

3—  
5

**sofa**

W 2720 D 1040 H 900  
W 107 1/8" D 41" H 35 3/8"

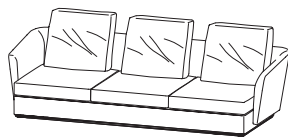

**DI272/A**

W 2720 D 1040 H 900  
W 107 1/8" D 41" H 35 3/8"  
single cushion seating

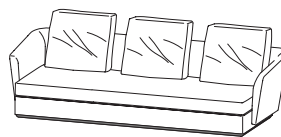

**DI272/B**

**pouf**

W 1000 D 880 H 400  
W 39 3/8" D 34 5/8" H 15 3/4"



**PO10/88**

W 1600 D 880 H 400  
W 63" D 34 5/8" H 15 3/4"



**PO16/88**

W 1300 D 1300 H 400  
W 51 1/8" D 51 1/8" H 15 3/4"



**PO13/13**

**end element**

W 1160 D 1040 H 900  
W 45 5/8" D 41" H 35 3/8"



**TE116 dx-sx**

W 1760 D 1040 H 900  
W 69 1/4" D 41" H 35 3/8"

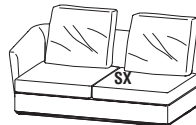

**TE176/A dx-sx**

W 1760 D 1040 H 900  
W 69 1/4" D 41" H 35 3/8"  
single cushion seating

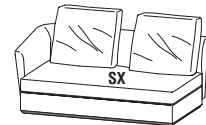

**TE176/B dx-sx**

**end element**

W 2160 D 1040 H 900  
W 85" D 41" H 35 3/8"

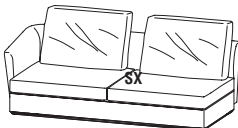

**TE216/A dx-sx**

W 2160 D 1040 H 900  
W 85" D 41" H 35 3/8"  
single cushion seating

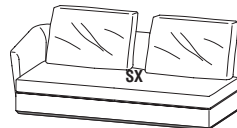

**TE216/B dx-sx**

**end element**

W 2560 D 1040 H 900  
W 100 3/4" D 41" H 35 3/8"

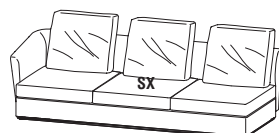

**TE256/A dx-sx**

W 2560 D 1040 H 900  
W 100 3/4" D 41" H 35 3/8"  
single cushion seating

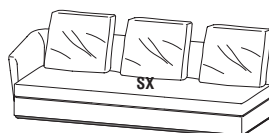

**TE256/B dx-sx**

**DATASHEET**

REGISTERED  
DESIGN

V.2017

## DIMENSIONS

**central element**  
W 1000 D 1040 H 900  
W 39 3/8" D 41" H 35 3/8"



**CN100**

W 1600 D 1040 H 900  
W 63" D 41" H 35 3/8"

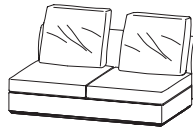

**CN160/A**

W 1600 D 1040 H 900  
W 63" D 41" H 35 3/8"  
single cushion seating

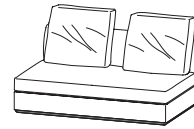

**CN160/B**

**corner element**  
W 1160 D 1040 H 900  
W 45 5/8" D 41" H 35 3/8"



**AG116 dx-sx**

W 2160 D 1040 H 900  
W 85" D 41" H 35 3/8"

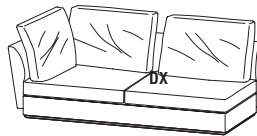

**AG216/A dx-sx**

W 2160 D 1040 H 900  
W 85" D 41" H 35 3/8"  
single cushion seating

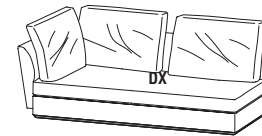

**AG216/B dx-sx**

**open corner element**  
W 2160 D 1040 H 900  
W 85" D 41" H 35 3/8"

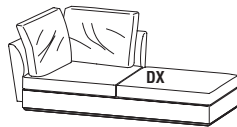

**AA216/A dx-sx**

W 2160 D 1040 H 900  
W 85" D 41" H 35 3/8"  
single cushion seating

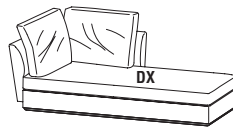

**AA216/B dx-sx**

**chaise longue**  
W 960 D 1460 H 900  
W 37 3/4" D 57 1/2" H 35 3/8"



**CH96 dx-sx**

W 1460 D 1460 H 900  
W 57 1/2" D 57 1/2" H 35 3/8"

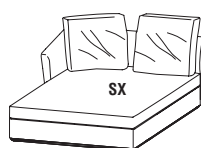

**CH146 dx-sx**

# Molteni & C

4—  
5

## DATASHEET

REGISTERED  
DESIGN

V.2017

## EXAMPLES OF COMPOSITIONS

Example of single seat cushions

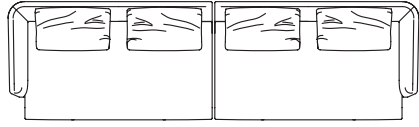

Example of divided seat cushions

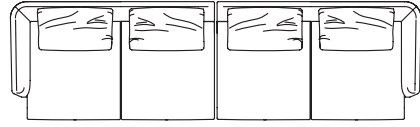

Molteni & C

Examples of compositions with Belsize small tables or Mayfair support bases

